

# Data Sheet



Article number: 03491045

Description: Fluro Heavy Duty Rod end EA 45 EW-2RS  
M42x3 Male thread

Note: 45

## Measures

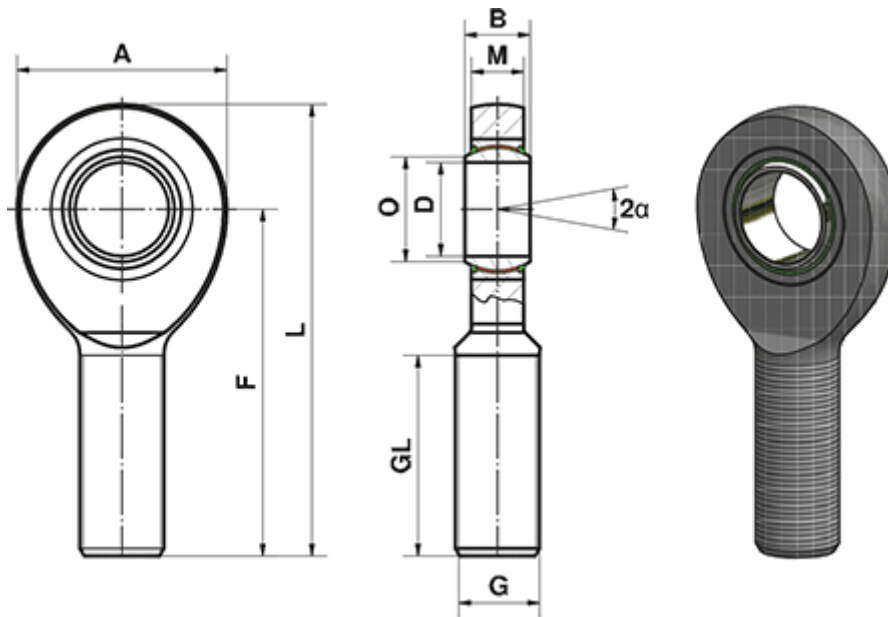

A	= 102	L	= 214
a (degrees)	= 7	M	= 25
B	= 32	O	= 50.7
D	= 45	Static load C0 (kN)	= 263
Dynamic load C (kN)	= 360	Weight (g)	= 2610
F	= 163		
G	= M42x3		
GL	= 94		